

# M8700

**INSTALLER'S MANUAL**  
**Release 00**



**Dear Installer,**

*Many thanks for choosing a MetaSystem product! Please read this manual carefully as you'll find it easier to understand the various possibilities that the range of M8700 products can offer you.*

After you have installed the product according to the "installation instructions" supplied with the product, and which you will also find below, the alarm control unit must be programmed in order to customise the product based on the vehicle that it is installed on.

When you have finished the job, it is important to remember to give the user's handbook to the owner of the vehicle and to show him the various features of his car alarm system. Please remember to fill out the "certificate of installation" in the user's handbook (European Directive) and to give the owner the red card that he will need should he decide to order any extra remote controls, as well as the OVERRIDE CARD where you should have already written the owner's emergency code, customised according to his choice.

**Best Regards !**

## **INDEX**

- Introduction	2
- The Range of M8700 products	3
- Technical specifications	3
- Instructions for installation	4
- Customising the operating functions	6
- Checking the setting of the operating functions	6
- Description of the operating functions	7
- The override code	10
- Remote controls	13
- Emergency keys	13
- Checking the remote controls and emergency keys	13
- The garage function	13
- The control unit's power supply	14
- Memory of triggered alarms	14
- Final Check	14
- Instructions for use	15

SPECIFICATIONS	basic		TOP	
	M8700	M8700A	M8700US	M8700AUS
<b>ARMING/DISARMING</b>				
TX mykro remote control with 2 keys and status LED, programmable function keys	•	•	•	•
Automatic alarm plant arming - selectable	•	•	•	•
Automatic arming of the engine immobiliser and/or alarm plant – selectable	•	•	•	•
Auto re-arming function – selectable	•	•	•	•
Emergency override code – can be customized	•	•	•	•
Emergency electronic key – OPT	OPT	OPT	OPT	OPT
<b>THE IMMOBILISER</b>				
Engine immobiliser relay (10A) can be selected instead of the horn output	•	•	•	•
<b>ALARM PLANT: protections and signals</b>				
Protection for doors/bonnet/boot – negative input	1 WIRE		2 WIRES WITH DIODES	
Auxiliary protection – positive input – can be inhibited via TX	•	•	M15mykro connector	
M15mykro ultrasonic volumetric protection – can be inhibited via TX			•	•
Power draw sensor – selectable	•	•	•	•
Key positive sensor	•	•	•	•
Panic alarm – selectable	•	•	•	•
Safety lock – automatic door locking when driving – controlled by brake pedal	•	•	•	•
Buzzer – selectable	•	•	•	•
Blinker	•	•	•	•
Electromagnetic siren	•		•	
Self-powered electromagnetic siren		•		•
Direct/alternate output for siren/horn control – can be selected instead of engine immobiliser	•	•	•	•
<b>UTILITIES</b>				
LED with alarm memory	•	•	•	•
Button/LED for override code	•	•	•	•
Central lock with time selection	3 WIRES		6 WIRES	
Dead Lock – double central locking command – selectable	•	•	•	•
Original comfort window winding command, automatic or via TX (M8)	•	•	•	•
US and auxiliary protection inhibition via TX	•	•	•	•
Garage function – automatic activations inhibited	•	•	•	•
Vehicle battery low signal	•	•	•	•
Doors open/alarm input test signalling	•	•	•	•
Key-4 – keypad for override code and anti car-hijacking – OPT	OPT	OPT	OPT	OPT
Remote control with 4 keys	OPT	OPT	OPT	OPT

## TECHNICAL SPECIFICATIONS

Power Supply.....	12Vdc (10V-15V)
Consumption M8700.....	disarmed 8 mA - armed 10 mA
M15 mykro.....	disarmed 8 mA - armed 10 mA (alarm disarmed) 6 mA
Operating temperature.....	-25°C+ 85°C
Sound level of siren.....	118 dB
Autonomy of back-up battery (SC1).....	5 minutes
Remote controls (max.7).....	72 million billion rolling codes (lithium batteries)
Emergency keys (max 4).....	18 billion billion rolling codes
Emergency “override” code to reset immobiliser and inhibit alarm functions.	

## RELAY CONTACT CAPACITY

Central door locking.....	10A
Relay for selection of engine immobilisation or control of horn .....	10A
Direction indicators relay.....	5A+5A

## TIMING

Initial immunity time.....	26 seconds
Duration of alarm cycle.....	26 seconds
Interval between alarm cycles.....	5 seconds
Delay for passive arming of engine immobiliser.....	(with engine off) 240 seconds
.....(with door open - engine off)	50 seconds
Delay for passive arming with alarm functions.....	30 seconds
Voltage drop sensor delay. ....	120 seconds
Intermittence of direction indicators when alarm triggered.....	0.4 sec.on 0.4 sec.off
Timing options for opening – closing doors.....	0.5 sec.-1.5 sec.-4.5 sec.-15 sec.
Timing for comfort closing.....	0.5-15 sec.
N° of permitted times for starting vehicle in garage mode.....	15
‘Distraction-proof’ re-arming.....	120 seconds

## ALARM CYCLES

Peripheral alarm inputs (doors, bonnet, boot).....	10 cycles
Ignition sensing.....	10 cycles
Ultrasonics.....	10 cycles
Auxiliary modules.....	10 cycles
Current drop sensor.....	10 cycles

# INSTRUCTIONS FOR INSTALLATION

## INSTALLATION

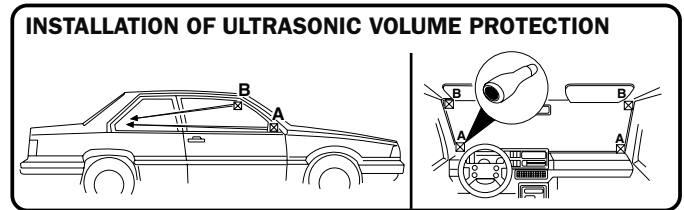
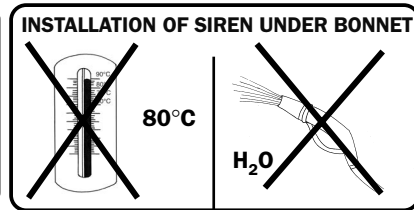
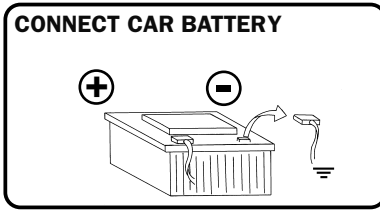

## CONNECTIONS

### GENERAL WIRING DIAGRAM

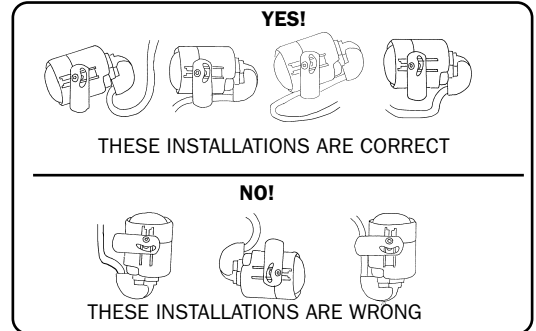
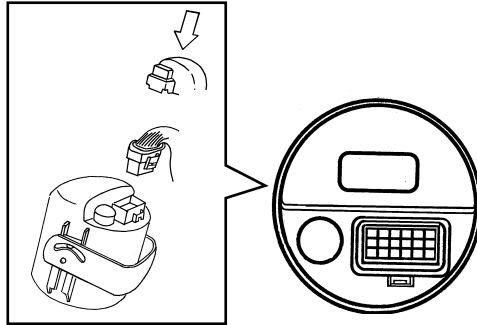

- ★ = ONLY USE THE EXISTING SWITCHES IF THEY CLOSE TO EARTH
- ▲ = THE 1,5 mm<sup>2</sup> BLACK WIRES ARE NORMALLY USED FOR THE ENGINE IMMOBILISATION CIRCUIT. ALTERNATIVELY IT IS POSSIBLE THE SETTING FOR THE HORN CONTROL (SEE INSTALLER MANUAL).
- ⊕ = AVAILABLE ONLY FOR TOP VERSION.

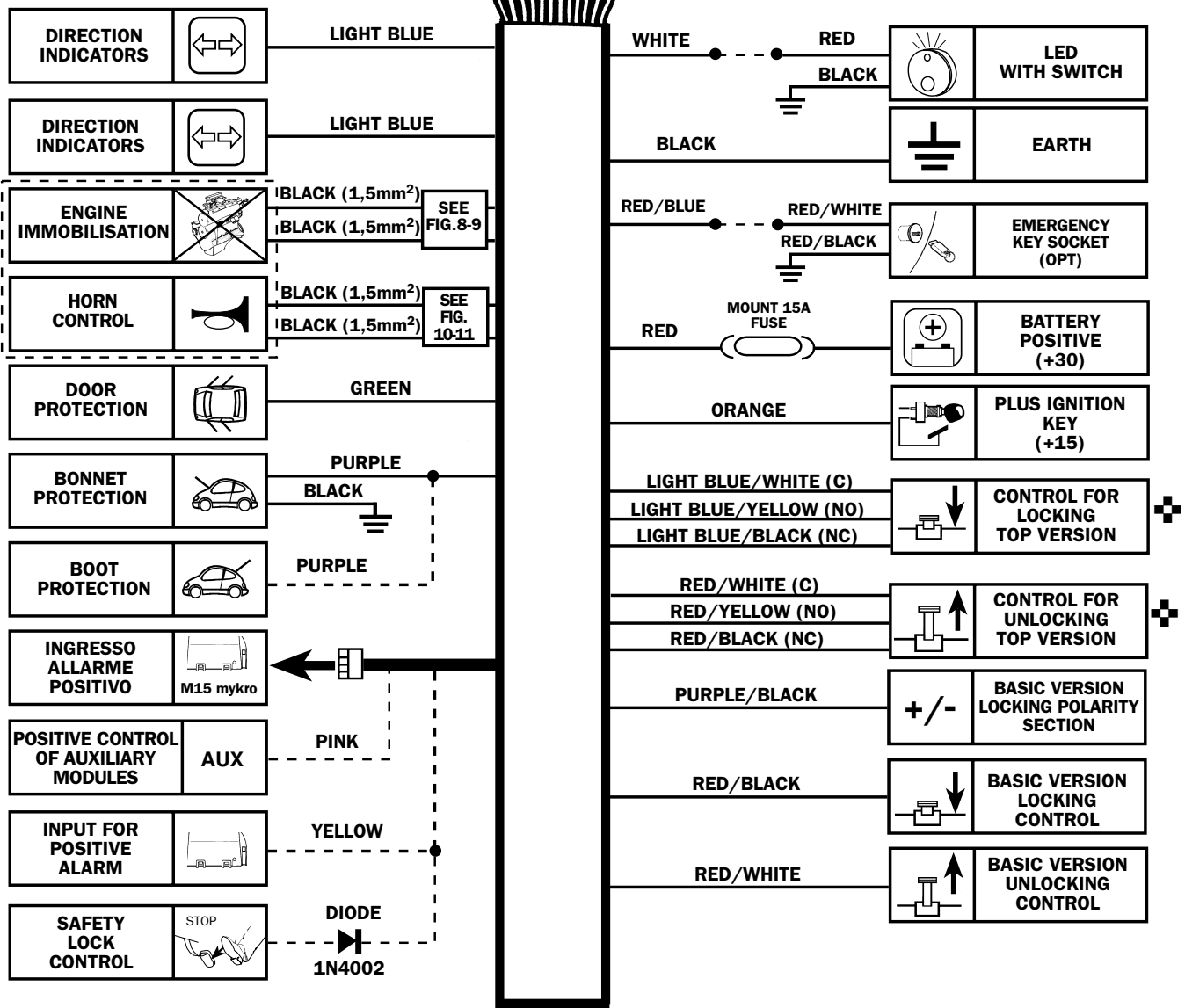

**PERIPHERAL PROTECTION – DOORS ★**

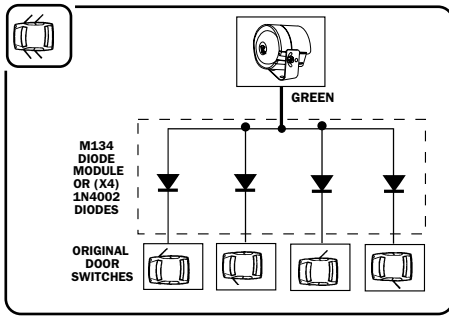

**PERIPHERAL PROTECTION – BONNET \* PERIPHERAL PROTECTION – BOOT ★**

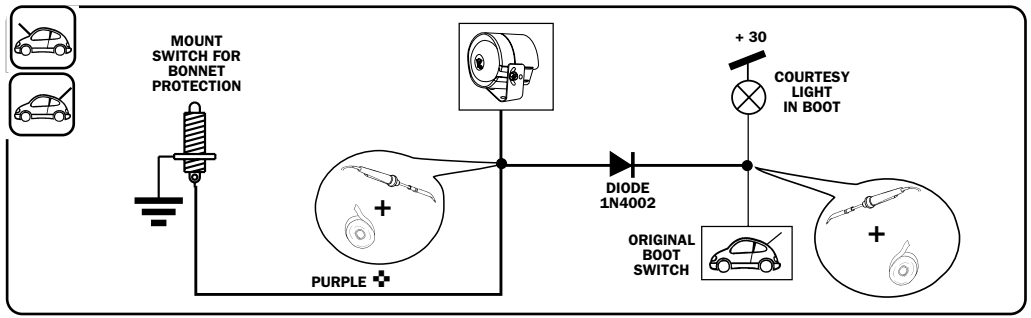

**WIRING LAYOUT FOR DOOR LOCKING WITH NEGATIVE POLARITY-TOP VERSION ❖**

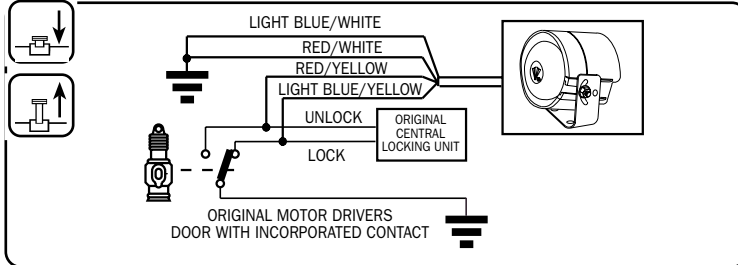

**WIRING LAYOUT FOR DOOR LOCKING WITH POSITIVE POLARITY-TOP VERSION ❖**

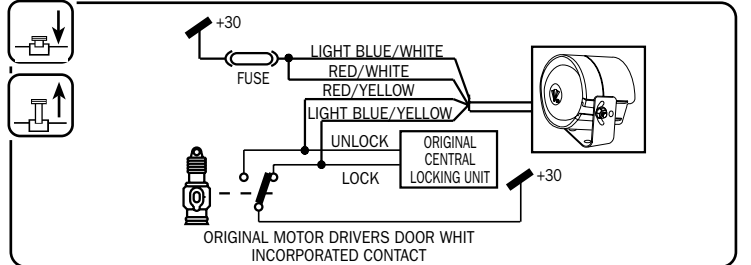

**WIRING LAYOUT FOR DOOR LOCKING WITH NEGATIVE POLARITY-BASIC VERSION**

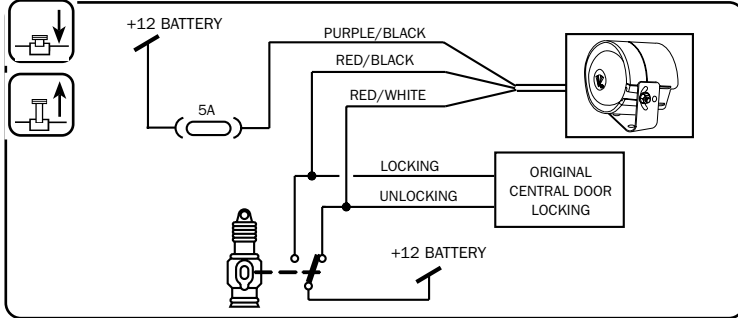

**WIRING LAYOUT FOR DOOR LOCKING WITH POSITIVE POLARITY-BASIC VERSION**

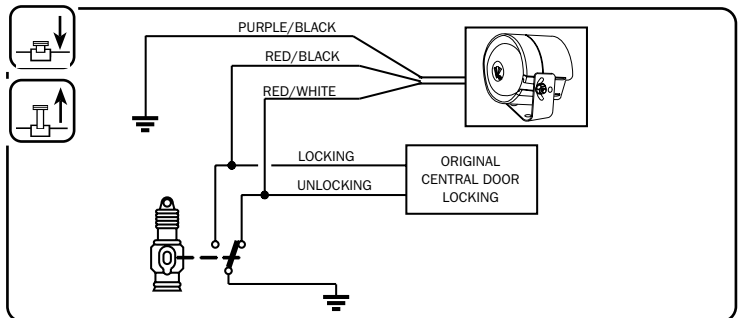

**IMMOBILISATION**

**THE 1,5 mm<sup>2</sup> BLACK WIRES ARE NORMALLY USED FOR THE ENGINE IMMOBILISATION CIRCUIT. ALTERNATIVELY IT IS POSSIBLE THE SETTING FOR THE HORN CONTROL (SEE INSTALLER MANUAL).**

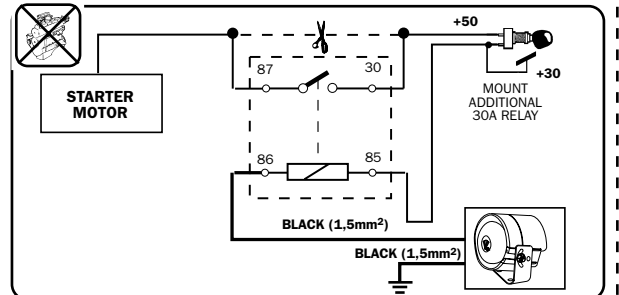
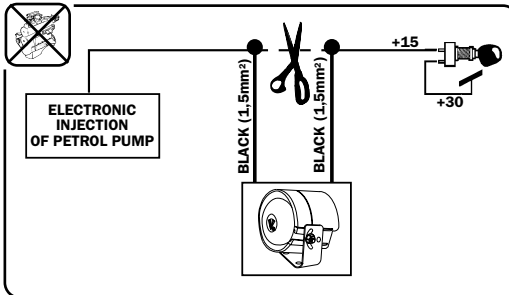

**HORN WITH POSITIVE CONTROL- SUBKEY**

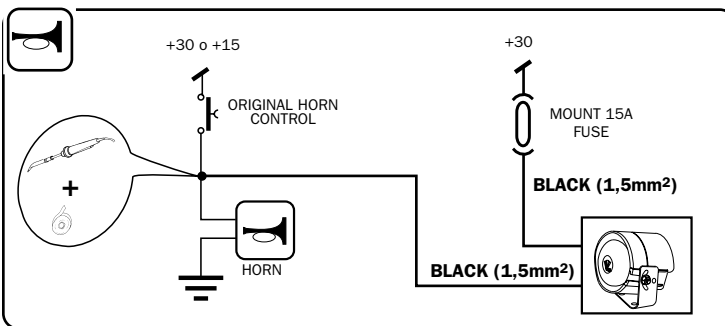

**HORN WITH NEGATIVE CONTROL- SUBKEY**

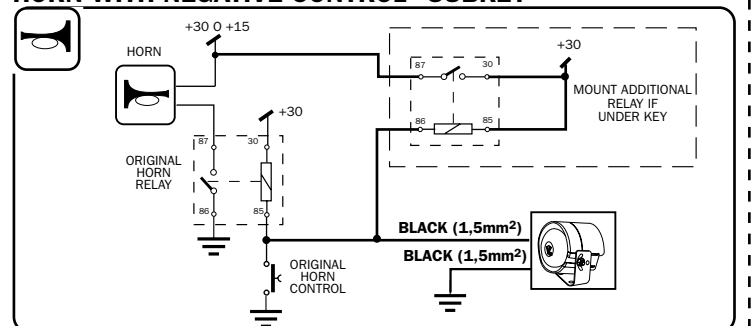

**FINAL CHECK**

- After completing the installation and connecting the connector of the harness to the alarm control unit, close the doors, bonnet, boot and windows and, proceed with the final check as follows, making sure that the vehicle keys and remote controls are not inside the vehicle.
1. Reconnect the car battery; the central unit is disarmed;
  2. Turn the car's ignition on to make sure the connections have been made correctly.
  3. Arm the alarm control unit with the remote control by pressing button A: the central door locking locks the doors, the protection of the alarm is armed, the direction indicators flash 2 times and the LED flashes.
  4. During the 25 seconds entry time, make the following tests; the indicators will flash if they are completed correctly:
    - open a door, the bonnet and the boot;
    - turn the ignition key to ON;
    - insert your hand in the open window and move it forwards and back with respect to the ultrasonic sensors. each time the indicators flash, the entry time is reset and starts again.
  5. After the initial entry time is over, the LED flashes at a slower rate and a 25 second alarm cycle will result if any of the alarm protections are triggered: the siren produces its characteristic modulated sound, the direction indicators flash and the horn, if connected, sounds intermittently. Check the correct operation of the engine immobilisation during the alarm cycle.
  6. Disarm the alarm control unit with the remote control by pressing button A: the central door locking unlocks the doors, the direction indicators flash once, the siren makes 1 BOOP sound and the LED flashes to signal the alarm memory. Refer to the installer's manual to decode the signal and for all the other features/settings of the product (the manual can be downloaded from website [www.metasystem.it](http://www.metasystem.it). Contact your dealer for information about access codes.)

## CUSTOMISING THE OPERATING FUNCTIONS

The installed alarm system has a series of preset factory settings, which can be modified according according to the vehicle that the alarm system is to be installed on as well as the owner's preferences.

The factory settings and their possible customisations are illustrated in the table below.

N°	TYPE OF FUNCTION	BUTTON A selection A (flashing led)	BUTTON B selection B (led off)	FACTORY SETTING standard configuration
1	buzzer	yes	no	no
2	control of horn/siren	continuous	alternating	alternating
3	safety lock	yes	no	no
4	delayed voltage drop sensor	delayed immediat	immediate	immediate
5	current drop sensor	yes	no	no
6	short timing for central door locking	0,5 sec	function 7	0,5 sec
7	long timing for central door locking	1,5 sec	4,5 sec	1,5 sec
8	comfort closing	yes-manual	no	no
9	automatic comfort	yes	no	no
10	dead lock	yes	no	no
11	not available	-	-	-
12	panic alarm	yes	no	no
13	test of peripheral alarms	yes	no	yes
14	not available	-	-	-
15	not available	-	-	-
16	not available	-	-	-
17	4-button remote control	yes	no	no
18	siren supplied	SC1	engine immobilisation	engine immobilisation
19	Key 4 keypad	yes	no	no
20	not available	-	-	-
21	distraction-proof rearming	yes	no	no
22	function of remote control buttonss	factory setting	custom setting	factory setting
23	passive arming with alarm functions	yes	no	no
24	passive arming of immobiliser	yes	no	no
25	peripheral alarms active	derived 1 alarm only	continuous	derived

Proceed as follows to modify the factory setting:

- arm the alarm system with the remote control;
- turn the ignition key to its ON position in order to switch the vehicle's dashboard on;
- press button A on the remote control 4 times (fig. 1): the direction indicators will flash each time the button is pressed;
- after the button is pressed for the fourth time, the siren will make a series of signals (4 BOOPS) to confirm that you have accessed the programming mode for the operating functions: the LED flashes quickly

**N.B.** it is possible to set one function at a time.

- Press the button on the SWITCH/LED module installed on the dashboard, or key 1 if the keypad is present, the same number of times as the function you want to set: the LED flashes slowly if the setting of the function is the "A selection" type and remains off if the setting is the "B selection" type.

**N.B.** The direction indicators will flash once each time the number indicating the type of function goes up to the next one.

If the keypad is present, the direction indicators will flash once to confirm the type of function has gone up to the next one (the beep that the keypad makes is not relevant).

You must wait for the flashing signal to stop before you press the button or Key 1 again.

The Led flashes quickly to indicate that a 'not used' function has been selected

To change the setting, press

- button A on the remote control if you want the setting as per "A selection": the siren makes one BEEP sound to confirm this, or press
- button B on the remote control if you want the setting as per "B selection": the siren makes one BOOP sound to confirm this;
- to change the setting of another function, repeat the 2 previous steps within 20 seconds;
- to exit the operating functions customisation phase, turn the ignition key back off and switch the vehicle's dashboard off, then disarm the system by pressing button A on the remote control.

**N.B.** During selection of a function, if you press the button on the SWITCH/LED or button 1 on the keypad, if present, for a number of times that corresponds to a function which is not used or one that does not exist, you will hear 4 BOOPS , and the LED will flash quickly to indicate the anomaly.

## CHECKING THE SETTING OF THE OPERATING FUNCTIONS

When customising the operating functions, you can check the status of each individual setting. The LED will indicate the current setting after you have pressed the button on the SWITCH/LED or button 1 on the keypad, if present, the same number of times as the function you want to check, as follows:

- slow flashing = "A selection" type setting

## DESCRIPTION OF THE OPERATING FUNCTIONS

1 - BUZZER - Factory Setting: disabled

The acoustic signal provided by the siren when the alarm system is armed and disarmed. Its use is not permitted in countries in the European Community.

2 - CONTROL OF HORN/SIREN - Factory Setting: alternating

Attention: function n° 18 must be enabled in order to use the Horn/Siren Control Function.

Signal to control the horn or an additional siren during an alarm cycle.

3 - SAFETY LOCK - Factory Setting: disabled

This function guarantees that the doors will always be locked via the central door locking system when the vehicle is in motion, and thus prevents any attempt to open the doors from the outside. The doors are locked automatically with the timing selected for UNLOCK TIMING. Connect the Yellow wire from the alarm control unit to the wire (positive impulse) coming from the micro switch inserted on the vehicle's brake pedal.

The locking control is performed the second time the brake pedal is pressed if the doors are locked and the instrument panel is on (+15 ON).

The doors will only be unlocked if a door is opened from the vehicle interior or if the engine is turned off.

4 - DELAYED VOLTAGE DROP SENSOR - Factory Setting: disabled

This makes it possible to arm the voltage drop sensor with a delay of 120 sec when the alarm system is armed.

The function is enabled for all vehicles which have electrical devices that may operate even after the ignition has been switched off (for example cooling fans).

Arming time with function enabled = 120 sec. from arming

Arming time with function disabled = 26 sec. from arming (initial immunity time).

5 - CURRENT DROP SENSOR - Factory Setting: disabled

As the alarm is being armed, the control unit memorises the consumption of the vehicle's electrical system and triggers an alarm if there is any variation in this. **WARNING:** the current drop sensor cannot replace peripheral protection because the current drop sensor will remain inactive if the bulb in the vehicle's interior light does not come on when a door is opened. N.B. To ensure correct operation of the current drop sensor, do not connect the alarm's positive supply directly to the battery, but to a derived line (e.g. fuse box). If operation of the current drop sensor has been selected, the 4 direction indicators can still be used in case of emergency without triggering an alarm even if the alarm is armed.

6\_7\_8\_9 - TIMING FOR CENTRAL DOOR LOCKING - Factory Setting: 0.5 seconds, comfort disabled  
It is possible to select the timing for locking and unlocking of the central door locking system from between 0.5 sec, 1.5 sec and 4.5 seconds.

In addition, if the comfort function is selected, the locking time depends on how long the button on the remote control is kept pressed, for up to maximum of 15 seconds. If the button is released before the 15 seconds are over, the control of the locking will be interrupted. If the automatic comfort function is selected, the locking time will be fixed at 15 seconds. When the comfort function is operational, the duration of the unlocking control can be 0.5 sec, 1.5 sec and 4.5 seconds. The possibilities for selection are shown in the table below

LOCKING TIME	UNLOCKING TIME	SETTING OF FUNCTIONS 6 - 7 - 8 - 9			
short = 0,5 sec.	short = 0,5 sec.	6 = selection A	7 = selection A	8 = selection B	9 = selection B
medium = 1,5 sec.	medium = 1,5 sec.	6 = selection B	7 = selection A	8 = selection B	9 = selection B
long = 4,5 sec.	long = 4,5 sec.	6 = selection B	7 = selection B	8 = selection B	9 = selection B
manual comfort 0,5÷15 sec.	short = 0,5 sec.	6 = selection A	7 = selection A	8 = selection A	9 = selection A
	medium = 1,5 sec.	6 = selection B	7 = selection A	8 = selection A	9 = selection A
	long = 4,5 sec.	6 = selection B	7 = selection B	8 = selection A	9 = selection A
automatic comfort 0,5÷15 sec.	short = 0,5 sec.	6 = selection A	7 = selection A	8 = selection A	9 = selection A
	medium = 1,5 sec.	6 = selection B	7 = selection A	8 = selection A	9 = selection A
	long = 4,5 sec.	6 = selection B	7 = selection B	8 = selection A	9 = selection A

10 - DEAD LOCK - Factory Setting: disabled

This function allows you to control an additional feature of the central door locking system using your remote control as it controls the safety locking of the vehicles with this system (Opels, recent Fiats etc) when both locking and unlocking the doors. The locking and unlocking controls are activated for the time set as per functions 6\_7\_8\_9 and then are reactivated for a further 0.5 sec after a pause of 0.5 sec. for locking and 1 sec for unlocking.

The Dead Lock controls are not produced during the activation of the Safety Lock function (if enabled).

11 - NOT AVAILABLE

12 - PANIC ALARM - Factory Setting: disabled

This function allows you to trigger a max 10 sec alarm cycle with the remote control; it can also be interrupted by remote control. Its operation depends on the setting of FUNCTION OF REMOTE CONTROL BUTTONS (function 22): **FACTORY SETTING:** when the control unit is not armed, trigger this function by pressing button B on the remote control; the same button can be used within 10 seconds to interrupt it. If the control unit is armed, the function can be triggered after the initial immunity time by pressing button B. Press it again within 10 sec, to stop the panic alarm.

**CUSTOM SETTING:** when the control unit is armed, the function can be triggered after the initial immunity time by pressing button A. Press it again within 10 sec to stop the panic alarm. It is not possible to trigger a panic alarm if the control unit is not armed.

13 - TEST OF PERIPHERAL ALARMS - Factory Setting: activated

Internal courtesy lights with delayed switch off or special connections may generate an open door status when the alarm control unit is armed; the siren signals this with 1 BOOP sound. If this is the case, we recommend neutralizing this function to eliminate the inaccurate signal.

14 - NOT AVAILABLE

15 - NOT AVAILABLE

16 - NOT AVAILABLE

17 - 4-BUTTON REMOTE CONTROL - Factory Setting: disabled

This function enables the use of a 4-button remote control, whose the functions are illustrated below:

BUTTON NUMBER	FUNCTION
1	only arming
2	only disarming
4	exclusion of ultrasonics

The procedure for linking up a 4-button remote control is the same used for traditional remote controls.

18 - RELAY FOR SELECTION OF ENGINE IMMOBILISATION OR CONTROL OF HORN - Factory Setting: engine immobilisation

This function makes it possible to control the horn or an additional siren using the 2 black wires with 1.5mm<sup>2</sup> section in the cable. This function clearly cancels and replaces the Engine Immobilisation control functions.

19 - KEY 4 KEYPAD - Factory Setting: disabled

The keypad replaces the LED/SWITCH and electronic emergency keys set (which can not operate together with the keypad). It is complete with a LED for signalling the status of the alarm system, a buzzer and 4 backlit keys (these light up the first time one of them is pressed and remain lit for 15 seconds after they were pressed for the last time).

20 - SAFETY LOCK CONTROL - Factory Setting: mileometer











See function 3

21 - DISTRACTION-PROOF REARMING FUNCTION - Factory Setting: disabled

This function enables the control unit to rearm the alarm system completely 2 minutes after it was last disarmed by remote control, provided the status of the doors, boot and bonnet remains unchanged during this time. If the volumetric protection was excluded when the system was previously armed, it will be excluded again when the system is automatically rearmed.

22 - FUNCTION OF REMOTE CONTROL BUTTONS

The way the buttons on the alarm system's remote control operate can be customised as shown in the table below: the system is supplied with the complete set of factory settings.

FUNCTION	FACTORY SETTING	CUSTOM SETTING
<b>ARMING:</b> with manual and automatic comfort closing of electric windows, if selected by installer	 BUTTON A	 BUTTON A
<b>DISARMING:</b> the system will rearm completely unless you enter the interior within 2 minutes and the distraction-proof function is enabled	 BUTTON A	 BUTTON B
<b>EXCLUSION OF ULTRASONIC VOLUME PROTECTION AND AUXILIARY MODULES:</b> press within 25 sec. of arming	 BUTTON B	 BUTTON A
<b>STOP ALARM CYCLE:</b> without disarming the system	 BUTTON B	 BUTTON A
<b>PANIC:</b> can be triggered when control unit is armed, after initial immunity time, max 10 sec. duration, can be stopped	 BUTTON B Can also be triggered if control unit is disarmed	 BUTTON A

23 - PASSIVE ARMING WITH ALARM FUNCTIONS - Factory Setting: disabled

This allows the peripheral protection of the alarm system to be armed automatically 30 seconds after the last open door is opened and the instrument panel is switched off (+15 OFF). The direction indicators flash 2 times to signal the system is armed and the LED flashes very quickly during the initial immunity time to indicate that the volume protection is not operational. After the initial immunity time, any alarm stimulus will trigger a PRE-ALARM signal lasting 5 seconds during which the siren will make a series of BEEP sounds: if the system is not disarmed before this time is over, a full alarm cycle will be triggered at the end of the pre-alarm signal. The alarm can be disarmed by means of the remote control.

Automatic passive arming can be temporarily neutralized with the garage function (see relative section)

24 - PASSIVE ARMING OF IMMOBILISER - Factory Setting: disabled

This allows the immobiliser to be armed automatically by the control unit:

- 4 minutes after the engine has been turned off, or

- 50 seconds after a door has been opened if the engine has been turned off

Automatic passive arming can be temporarily neutralized with the garage function (see relative section)

25 - PERIPHERAL ALARMS ACTIVE - Factory Setting: derived (1 alarm only)

It is possible to choose if an ongoing alarm trigger is to correspond to a single alarm cycle, or to consecutive alarm cycles up to a maximum of 10 (European Directive)



## THE OVERRIDE CODE

In emergency situations, the alarm system can be neutralized by means of the OVERRIDE code. This is keyed in by using the button on the SWITCH/LED mounted on the dashboard or via the KEY4 keypad, if present. The code set during production in the factory is the same for all control units, i.e. 1 1 1 1 1 or 1111 if the keypad is enabled.

It is absolutely essential to customise this code; ask the owner of the vehicle for a sequence of 5 digits of his choice, not including 0, if the SWITCH/LED is mounted. If the keypad has been mounted the code has 4 digits made up of the keys 1, 2, 3 and 4 on the keypad. This code must be stored in the control unit's memory as shown in the procedure below, and then noted on the OVERRIDE CARD provided with the system and kept in a safe place by the owner of the vehicle.  
CUSTOMISING THE OVERRIDE CODE WITH SWITCH/LED

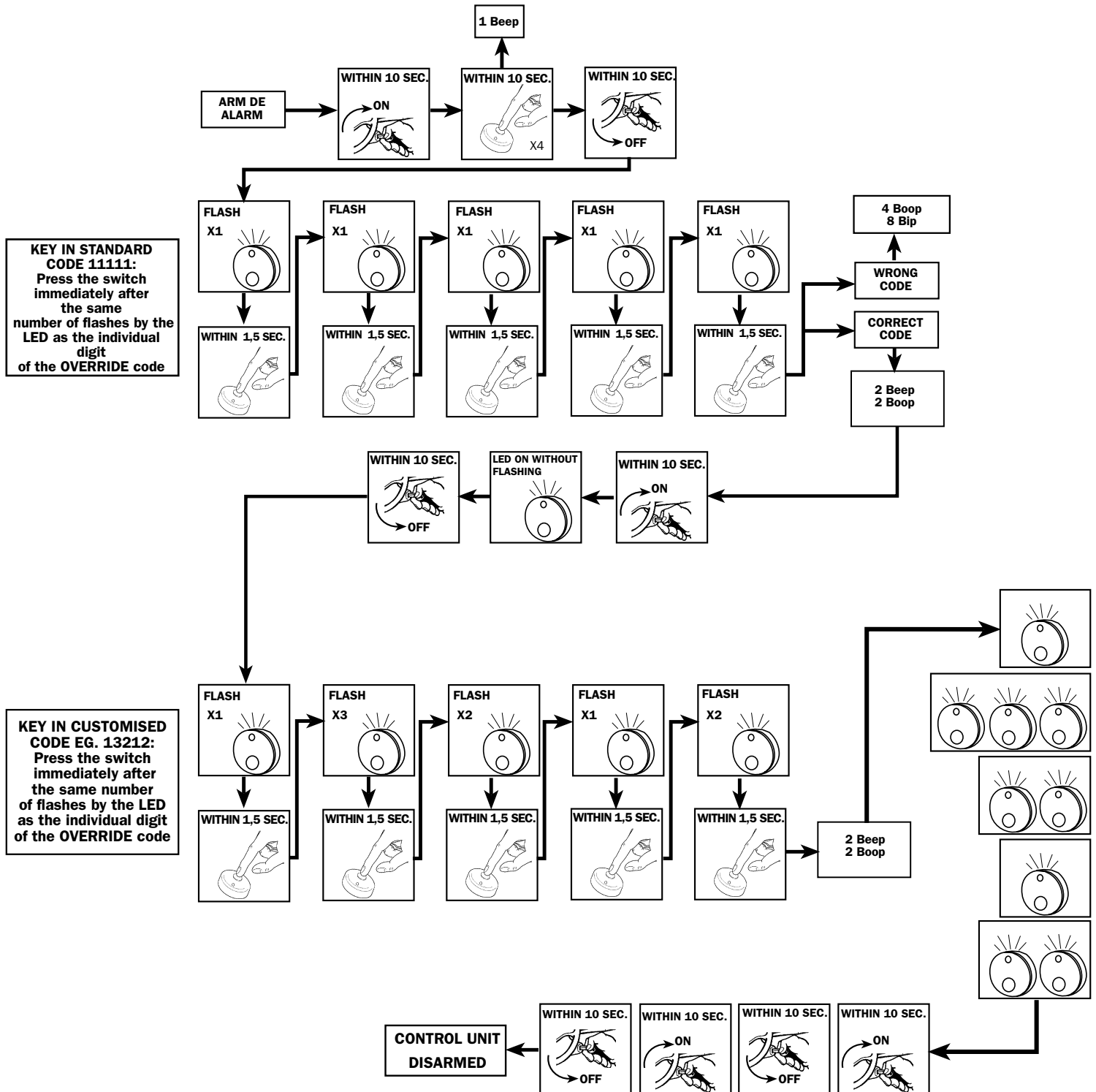

CUSTOMISING THE OVERRIDE CODE WITH KEYPAD

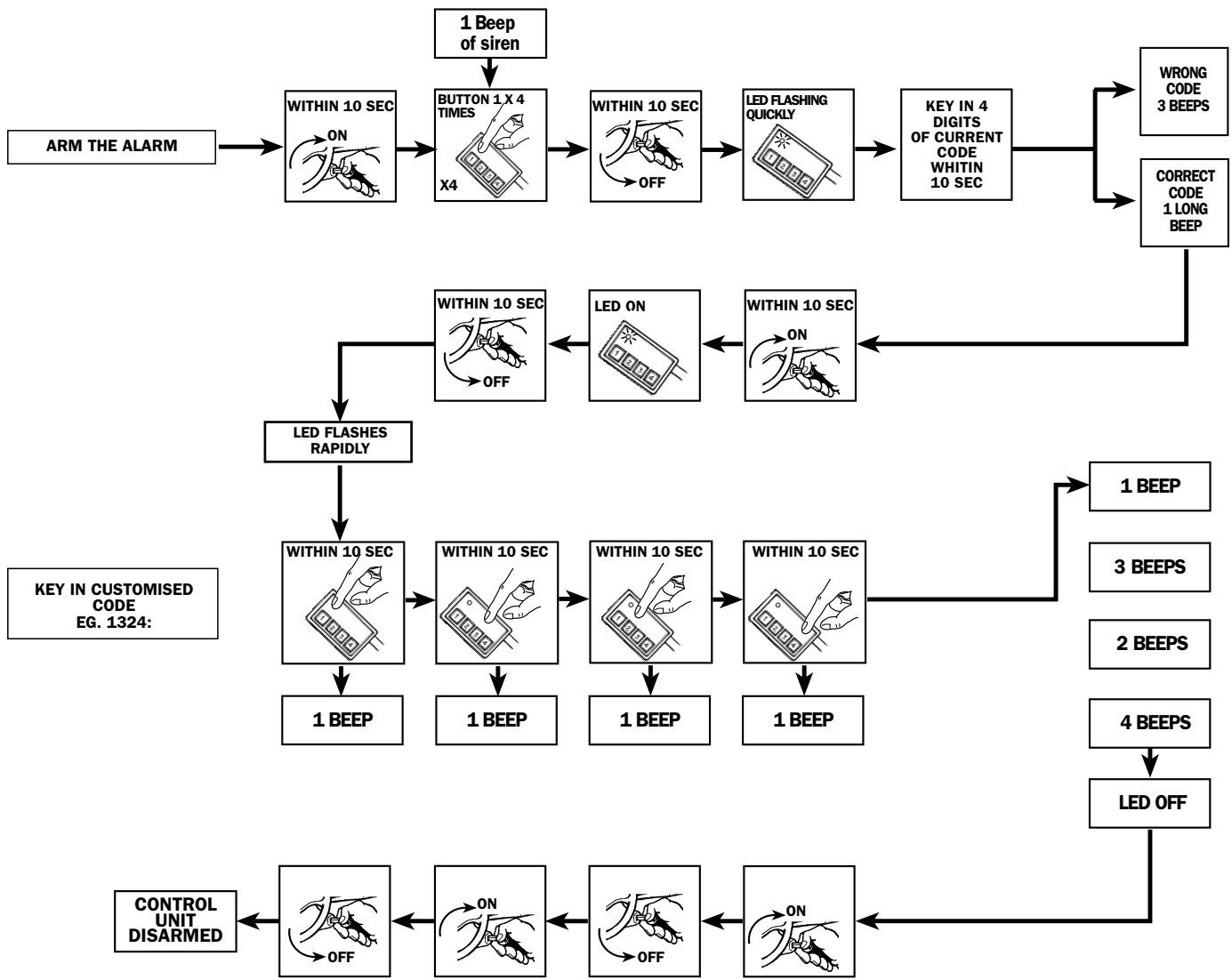

## USE OF OVERRIDE CODE

The procedure is only operative after the initial immunity time is over.

Alarm cycles will be triggered whilst the code is being keyed in. If the button on the SWITCH/LED does not work, it can be replaced by turning the vehicle's ignition key ON and OFF.

When the alarm is armed, follow the procedure shown for the disarming of the M8700 control unit.

### LED/SWITCH PROCEDURE

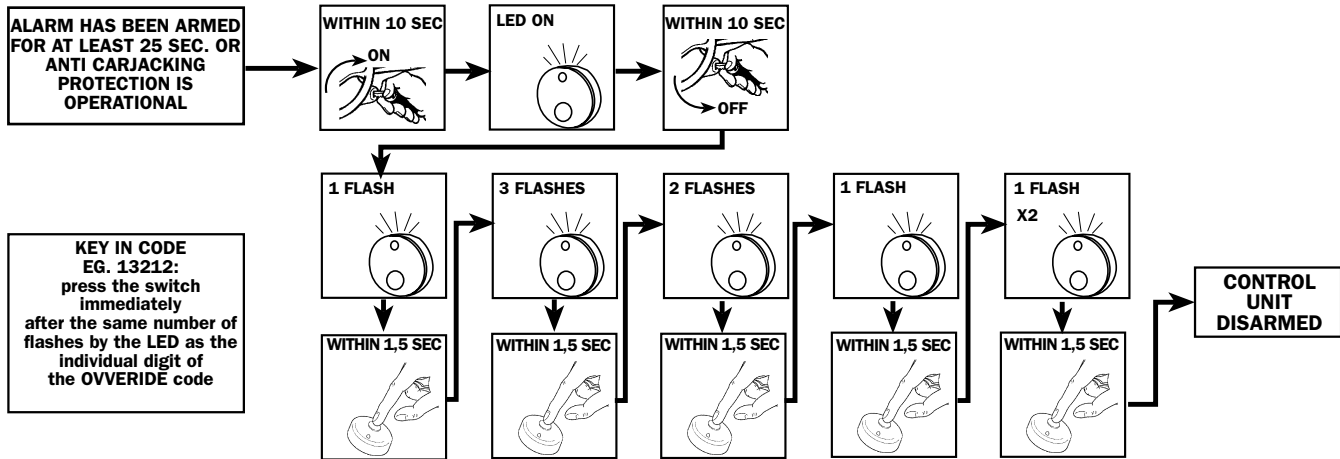

### KEYPAD PROCEDURE

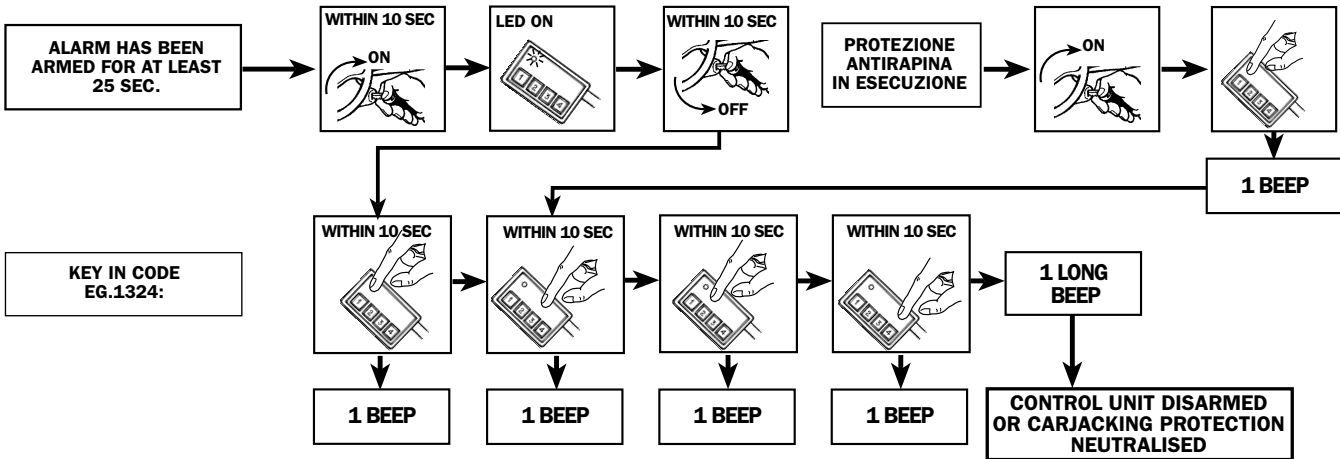

WARNING: if the wrong code is keyed in 3 times, the control unit will be blocked for 10 minutes to prevent attempts to acquire the code.

### RESETTING THE OVERRIDE CODE

If a code is lost or forgotten, it is possible to restore the 1 1 1 1 1 factory setting, or 1111 if there is a keypad enabled; it should then be customised again with the vehicle owner's new code. This cannot be done if the system is armed (it must first be disarmed). You must have both remote controls to do this and follow the procedure below:

- disarm the control unit;
- turn the vehicle's ignition key ON (dashboard turned on);
- press button A on one of the 2 remote controls;
- press button A on the second remote control;
- press button A on the first remote control again;
- press button A on the second remote control again. The M02 siren will now confirm that the code has been reset by sounding 2 BEEPS followed by 2 BOOPS.
- turn the vehicle's ignition key OFF (dashboard turned off);

N.B. Make sure that less than 5 seconds pass between one step and the next.

### REMOTE CONTROLS

The alarm control unit is supplied with 2 coded remote controls but it is possible to add extra remote controls, up to a maximum of 7 in all. To add new remote controls, they must first of all be ordered from your local MetaSystem Customer Care Centre; you must indicate the base code, located on the red card supplied with the product, on your order. After you receive the remote controls, they have to be linked up to the control unit by means of the dedicated link-up procedure. If one or more remote controls are lost or stolen, they can be cancelled by means of this same link-up procedure, and even reset for use should they be found again.

## LINKING UP REMOTE CONTROLS

- a) arm and disarm the control unit with the remote control 16 consecutive times; the siren will produce 2 BEEP's and 2 BOOP's after the 16th time.
- b) turn the ignition key ON within 10 secs (vehicle's dashboard is turned on);
- c) press button A on the new remote control: the LED turns on;
- d) press button A on the same remote control again: the LED turns off and the siren makes a BEEP to confirm it has been successfully linked up;
- e) press button A on the second new remote control: the LED turns on;
- f) press button A on the same remote control again: the LED turns off and the siren makes a BEEP to confirm it has been successfully linked up;
- g) repeat steps e and f for all the new remote controls;
- h) turn the ignition key to the OFF position (vehicle's dashboard is turned off): the siren will produce 2 BEEP's and 2 BOOP's to confirm the memorisation has been completed.

## **EMERGENCY KEYS**

The alarm system can be equipped with up to 4 electronic keys for emergency disarming.

The EMERGENCY KEYS KIT (P64760) includes the receptacle, to be installed as shown in fig. 1/A, and 2 keys, which must be stored in the control unit's memory as described in the procedure for memorising emergency keys. It is also possible to neutralize any lost or stolen keys by means of the same procedure, as the memorising of emergency keys automatically deletes any previously stored keys.

## MEMORISING EMERGENCY KEYS

- a) arm the control unit with the remote control;
- b) within 10 seconds of this, turn the vehicle's ignition key ON (dashboard is turned on);
- c) within 10 seconds of this, press the button on the SWITCH/LED 4 times: the siren will BEEP once to confirm selection;
- d) within 10 seconds of this, turn the vehicle's ignition key OFF (dashboard is turned off): the LED will start to flash slowly thus requesting the override code. The button must be pressed immediately after the equivalent number of flashes of the LED as each individual digit in the override code;
- e) the siren will produce 2 BEEP's followed by 2 BOOP's to confirm that the correct override code has been keyed in;
- f) insert the emergency keys into the receptacle within 10 seconds: the LED will flash once to confirm each key has been memorised correctly;
- g) to exit the procedure and permanently store the keys in the alarm control unit's memory, press button "A" on one of the 2 remote controls or turn the ignition key ON and back OFF 3 times each.

## **CHECKING THE QUANTITY OF REMOTE CONTROLS AND EMERGENCY KEYS**

When the alarm system is disarmed, turn the vehicle's ignition key ON (dashboard is turned on) and press button A on the remote control: the LED will flash the same number of times as the number of remote controls that are stored in the control unit's memory. After a pause of 2 seconds, the flashing will start again to indicate how many emergency keys have been stored in its memory.

## **THE GARAGE FUNCTION**

This function makes it possible to temporarily bypass the passive immobiliser arming function, the passive alarm arming and anti-distraction function.

It is enabled by pressing button A on the remote control and the button on the SWITCH/LED, installed on the dashboard, at the same time: 1 flash of the direction indicators and 1 BOOP sound by the siren confirm it has been enabled correctly. With the ignition key in the ON position (dashboard turned on), the LED will flash to confirm that the garage function has been selected. If the keypad has been enabled, press 2 buttons at the same time and press button A on the remote control: the keypad will produce 4 BEEP's to confirm it has received the signal. Release the 2 buttons and key in the override code within 10 seconds: 2 flashes of the direction indicators and 2 BEEP sounds by the siren indicate confirm the function has been enabled. When the garage function is enabled, it is possible to turn the ignition on 15 times and it remains in the alarm control unit's memory even if its power supply is disconnected.

The garage function is cancelled immediately with use of the remote control.

## **THE CONTROL UNIT'S POWER SUPPLY**

If the control unit's power supply is disconnected, its memory will store its previous status. When its power supply is restored, the status of the control unit will be the same as just before the power supply was disconnected.

## **AUTOMATIC SWITCH OFF (ONLY FOR VERSION WITH BATTERY BACK UP)**

The M8700A control unit will switch off automatically if the vehicle battery is disconnected when the alarm control unit is disarmed, or if the voltage at the battery terminals drops below 3V. This is to prevent damage to its internal batteries.

The M8700A control unit will exit this "automatic switched-off" status and return to its normal operation mode after the vehicle's battery has been reconnected and the ignition key has been turned to switch the dashboard on.

## **MEMORY OF TRIGGERED ALARMS**

If various alarms have been triggered, the siren will make the Boop sounds when the control unit is disarmed and the LED will produce the sequences of signals in its memory with 3-second pauses, repeating the sequences every 6 seconds. The memory is reset when the vehicle's ignition is turned on or when the control unit is armed again by remote control.

<b>LED SIGNAL</b>	<b>TYPE OF ALARM TRIGGERED</b>
1 FLASH	ULTRASONIC
2 FLASHES	DOORS
3 FLASHES	BONNET
4 FLASHES	BOOT
5 FLASHES	AUXILIARY MODULES (POSITIVE ALARM)
6 FLASHES	DASHBOARD (+15)
7 FLASHES	CURRENT DROP SENSOR

## FINAL CHECK

After the alarm system has been installed and customised, it is important to check that it operates correctly by means of the following procedure:

- connect the cable's connector to the M8700 control unit
- close the boot, sun-roof, all windows and doors
- make sure that you have not left the car keys or the remote controls inside the vehicle
- restore the connection of the car battery, then close the bonnet
- the first time it is switched on, the control unit will be disarmed
- start up the engine to check that all connections have been carried out correctly











The checks described below refer to a control unit with standard factory settings: the results of the various steps may vary according to any customisation of the operating functions.

- arm the control unit by pressing button A on the remote control: the doors are locked by the central door locking system, the alarm protection is operational, the direction indicators flash 2 times and the LED flashes
- during the initial 25 seconds of immunity time, complete the following tests, each of which should cause the indicators to flash once, signalling the positive outcome of the test:
  - open a door, the bonnet and the boot
  - turn the ignition key ON
  - insert your hand through an open window and move it backwards and forwards compared to the installed ultrasonic capsules; the initial immunity time starts again from zero every time the indicators flash
- after the initial immunity time is over, the LED will flash more slowly and there will be a 25 second alarm cycle if you trigger any of the alarm's protection features: the siren produces its distinctive modulated sound, the direction indicators flash and the horn ,if connected, sounds intermittently. Check that the immobiliser is working properly during an alarm cycle.
- disarm the alarm control unit with the remote control by pressing button A: the central locking system will unlock the vehicle's doors, the direction indicators will flash once, the siren will make 1 BOOP sound and the LED will flash to indicate the alarms stored in its memory triggered during the final test.

Please refer to the instructions of the individual auxiliary modules for more information on their operation, if any are installed.

## ISTRUCTIONS FOR USE

### MAIN CONTROLS AND SIGNALS (\* configuration must be made)

FUNCTIONS	FACTORY SETTING	*CUSTOM SETTING	INDICATORS	SIREN	LED
<b>ARMING:</b> with manual and automatic comfort closing of electric windows if selected by installer.	 BUTTON A	 BUTTON A	2 FLASHES	2 BEEPS (if buzzer ON*) If peripheral protection is active: 1 BOOP (if buzzer ON*)	FLASHING: turns off briefly during first 25 sec. (initial immunity time), then flashes slowly
<b>DISARMING:</b> if you don't get inside the car within 2 minutes when the distraction-proof function has been enabled, the system will completely rearm. The system is completely disarmed during an alarm.	 BUTTON A	 BUTTON B	1 FLASH	1 BEEP (if buzzer ON*) and no alarms were triggered. If alarms were triggered (after the BEEP if buzzer ON*): M02= 1 BOOP-SC1= 2 BIPS 1 BEEP + 4 rapid BEEPS (if vehicle's battery is flat and buzzer ON*)	Turns off if no alarms were triggered, otherwise flashes to signal memorised alarms (see relative table)
<b>EXCLUSION OF ULTRASONIC VOLUME PROTECTION AND AUXILIARY MODULES:</b> press within 25 sec. of arming.	 BUTTON B	 BUTTON A	3 FLASHES EACH TIME BUTTON IS PRESSED	3 BEEPS each time button is pressed (if buzzer ON*)	FLASHING: rapidly during first 25 sec. (initial immunity time) then flashes slowly
<b>STOP ALARM CYCLE:</b> without disarming the system	 BUTTON B	 BUTTON A	FLASHING STOPS	SOUNDING STOPS	FLASHING: Flashes slowly
<b>* PANIC:</b> can be activated when control unit is armed, after initial immunity time, max duration 10 sec., can be interrupted by pressing same button	 BUTTON B BUTTON B can also be activated when control unit is disarmed	 BUTTON A	FLASHING	SOUNDING	Same as previous status

### ADDITIONAL SIGNALS (\* configuration must be made)

FUNCTIONS	INDICATORS	SIREN	LED
<b>ALARM:</b> 25 sec. cycle can be stopped by remote control	FLASHING	SOUNDING	OFF
<b>* PASSIVE ARMING OF ENGINE IMMOBILISER:</b> arms 4 minutes after the engine is turned off, or 50 sec. after a door is opened (with engine off).	1 FLASH	—	Flashing very slowly
<b>* PASSIVE ARMING OF ALARM + IMMOBILISER:</b> arms 60 sec. after opening and closing a door (with engine off).	2 FLASHES	—	Flashing very slowly during first 25 sec. (initial immunity time)
<b>PRE-ALARM:</b> only if passive arming of alarm has been enabled or if armed by electronic key. An alarm cycle is produced after 5 sec.	—	Series of BEEPS for 5 sec.	Same as previous status

#### GARAGE FUNCTION

Enables the passive arming of the engine immobiliser, passive arming of alarm, distraction-proof re-arming and anti-carjacking functions to be temporarily neutralised. If the garage function is enabled, the engine can be turned on 15 times and remains memorised even if the alarm control unit's power supply is disconnected.

When the ignition key is ON (instrument panel ON) the LED will flash to indicate that the garage function has been selected. Use of remote control will cancel this setting.

Enabling of the garage function is obtained with:

SWITCH LED: press button A on the remote control and the button on the LED at the same time; the direction indicators flash once and the siren makes 1 BOOP sound.

#### KEY4 Keypad:

press 2 buttons on the keypad at the same time and press button A on the remote control to transmit a signal: the keypad will produce 4 BEEPS to confirm reception. Release the 2 buttons and key in the override code within 10 sec: the direction indicators flash 2 times and the siren produces 2 BEEPS to confirm the function has been activated.

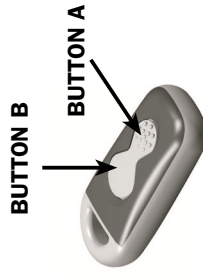

TX mykro

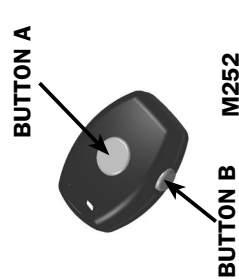

M252



# The best technology for your security



[www.metasystem.it](http://www.metasystem.it)

MetaSystem S.p.A. • Via Galimberti, 8  
42100 Reggio Emilia • ITALY  
Tel. +39-0522 364 111 • Fax +39-0522 364 150  
[info@metasystem.it](mailto:info@metasystem.it)



V810080A © Copyright by MetaSystem 12/2001

GRAFTALIA (RE). Printed in Italy Data and technical features may be changed without notice.